

No	a*b	X
1	296x446	1
2	418x101	2
3	284x381	2
4	451x381	1
5	452x402	1
6	297x447	1

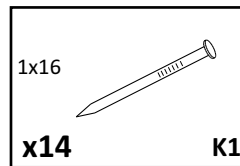

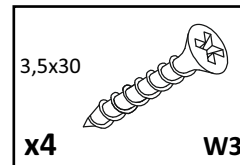

1

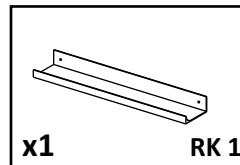
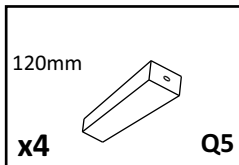
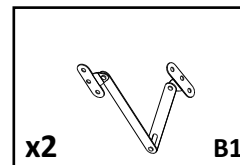
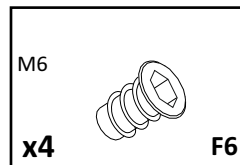
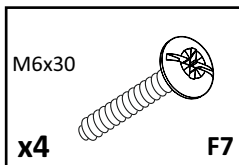
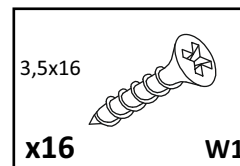
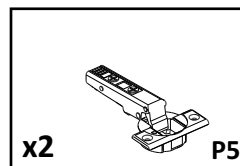
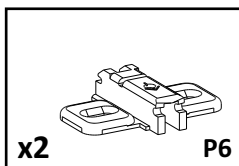
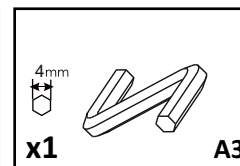
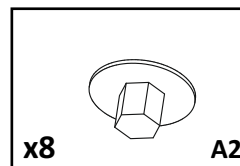
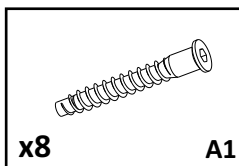
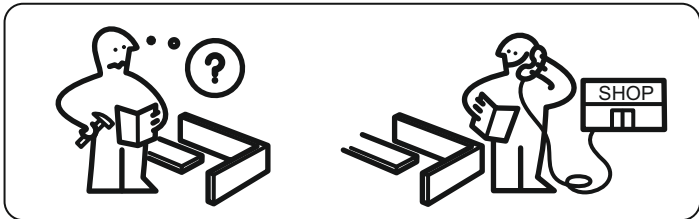
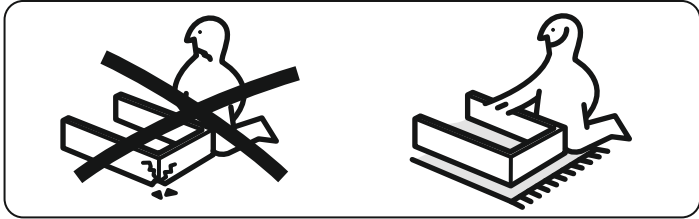
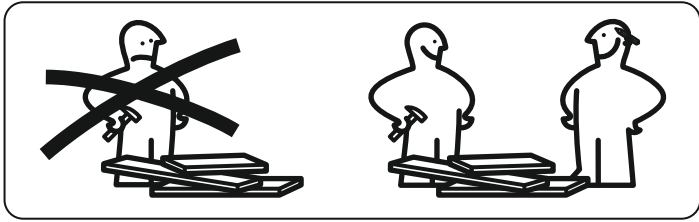
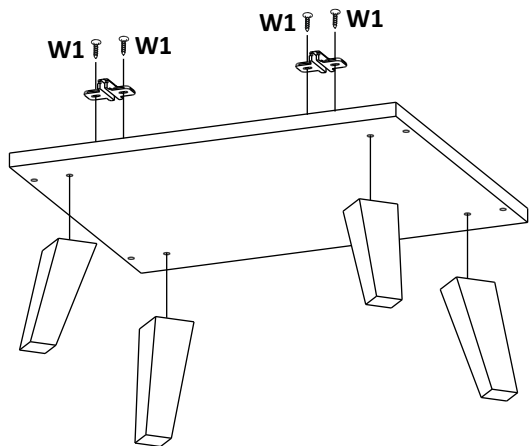
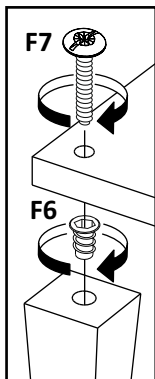
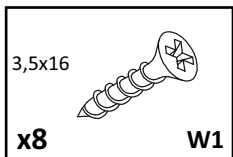
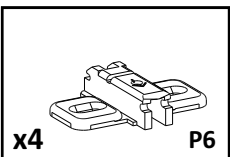

2

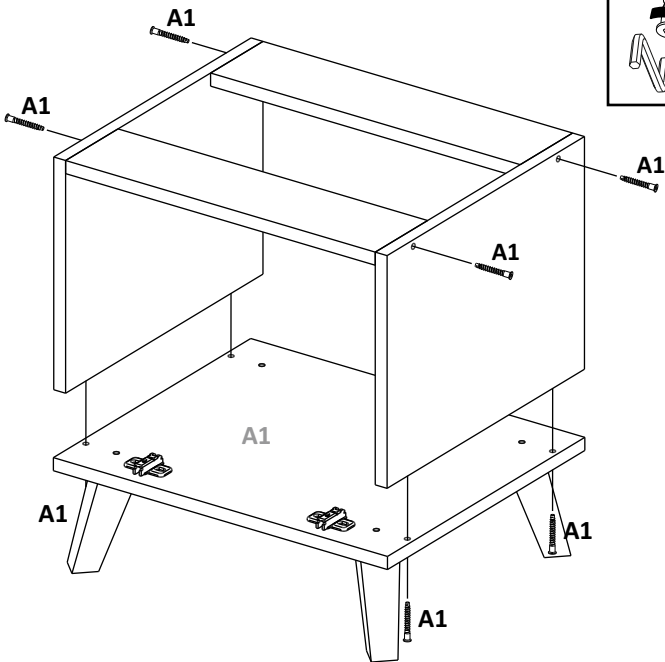
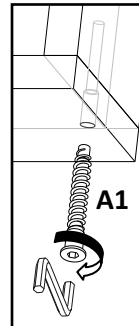
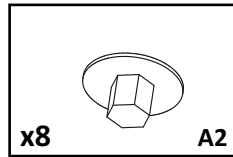
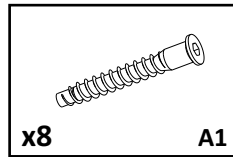

3

3,5x30

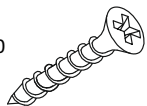

x4

W3

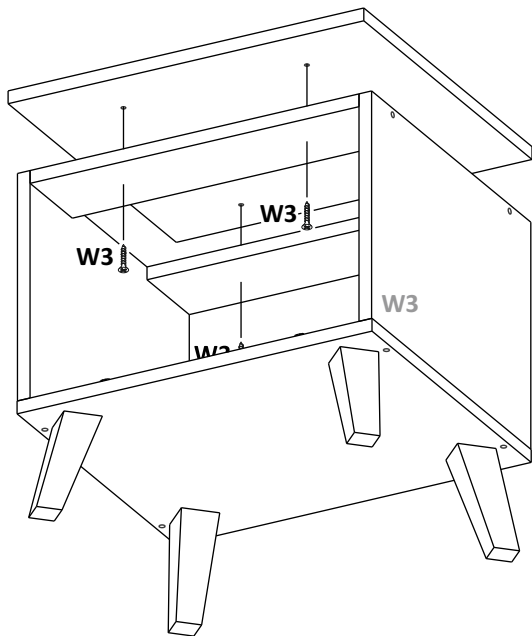

4

1x16

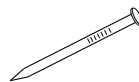

x14

K1

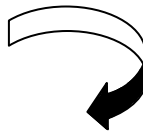
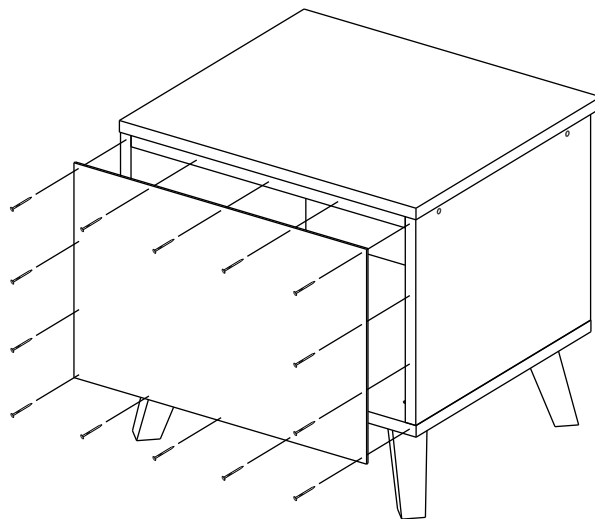
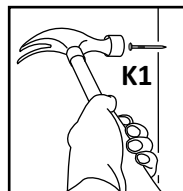
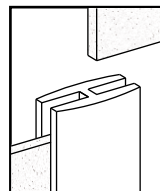

5

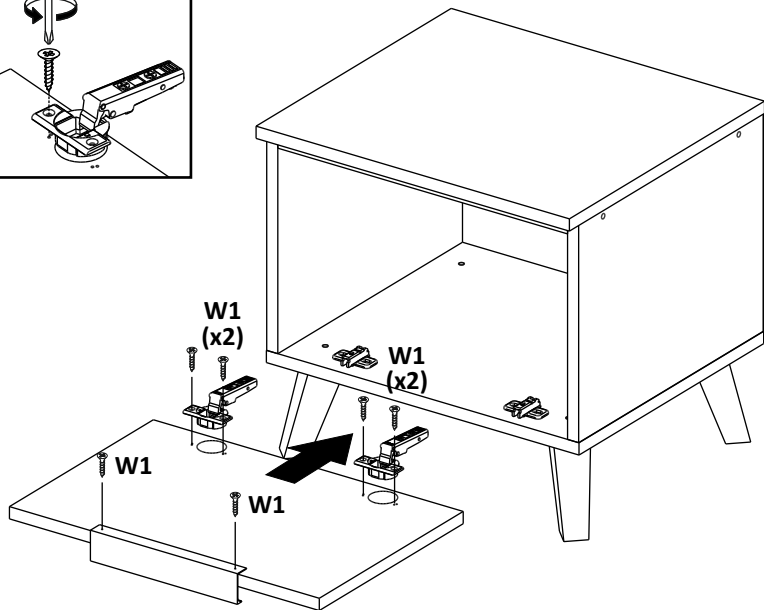
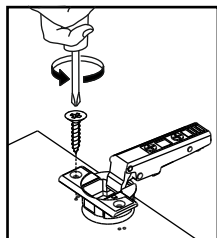
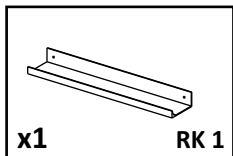
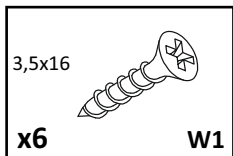
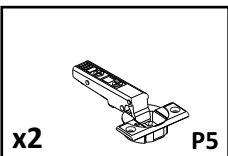

6

